

Part Count:

OR-K-ATL3, 10' x 10' Kit Size



<p>JUNCTION BOX (OR-J-3) DBL JUNCTION BOX (OR-J-DBL)</p> <p>4 0</p>	<p>24" LONG TRUSS SECTION (OR-24-2)</p> <p>0</p>	<p>46" LONG TRUSS SECTION (OR-46-2)</p> <p>4</p>	<p>HAND TOOL (OR-TOOL-B)</p> <p>1</p>	<p>ADJUSTABLE TABLE TOP (OR-TBL)</p> <p>*-S *-B *-WD *-DWD</p> <p>0</p>
<p>(OR-B45)</p> <p>4</p>	<p>30" LONG TRUSS SECTION (OR-30-2)</p> <p>0</p>	<p>45 CURVED TRUSS SECTION (OR-45-CV-2)</p> <p>7</p>	<p>TRUSS TO JUNCTION (OR-QL-T2J) TRUSS TO TRUSS (OR-QL-T2T)</p> <p>17 6</p>	<p>LEFT (OR-TBL2-L) RIGHT (OR-TBL2-R)</p> <p>ADJUSTABLE SCALLOP TABLE TOP</p> <p>*-S *-B *-WD *-DWD</p> <p>0 0</p>
<p>(OR-B90)</p> <p>0</p>	<p>36" TRUSS SECTIONS (OR-36-2)</p> <p>0</p>	<p>90 CURVED TRUSS SECTION (OR-90-CV-2)</p> <p>0</p>	<p>SPOTLIGHT (CHOICE OF LIGHTS)</p> <p>2</p>	<p>45 CURVED INTERNAL SHELVES (OR-CIS-45)</p> <p>*-S *-B *-WD *-DWD</p> <p>0</p>
<p>(OR-B90A)</p> <p>0</p>	<p>(OR-LCD-1-S) 0 (OR-LCD-2-S) 1 Opti Mount (OR-LCD-3-S) 0</p>	<p>UNIVERSAL CONNECTOR (OR-UNI-CLP-1) 0 LIT RACK (OR-STG) 0</p>	<p>(OR-IS-24) 24" 0 (OR-IS-36) 36" 0 (OR-IS-46) 46" 0 (OR-IS-48) 48" 0</p> <p>INTERNAL SHELVES</p> <p>*-S *-B *-WD *-DWD</p>	<p>(OR-SE-IS-90) 0 (OR-CIS-90) 0 90 CURVED INTERNAL SHELVES 0</p> <p>*-S *-B *-WD *-DWD</p>

Each Orbital Express Truss kit has been carefully designed and developed to be stable and safe. Consult with your dealer for load bearing specifications. The manufacturers of Orbital Express Truss will not be held responsible or accountable for any damage or injury caused by exceeding guidelines or though wrongful/incorrect use of the system.

Note: Shelf finishes may vary. Kits will come with choice of lights except for Lumina 2.

Graphic Specs:

OR-K-ATL3, 10' x 10' Kit Size

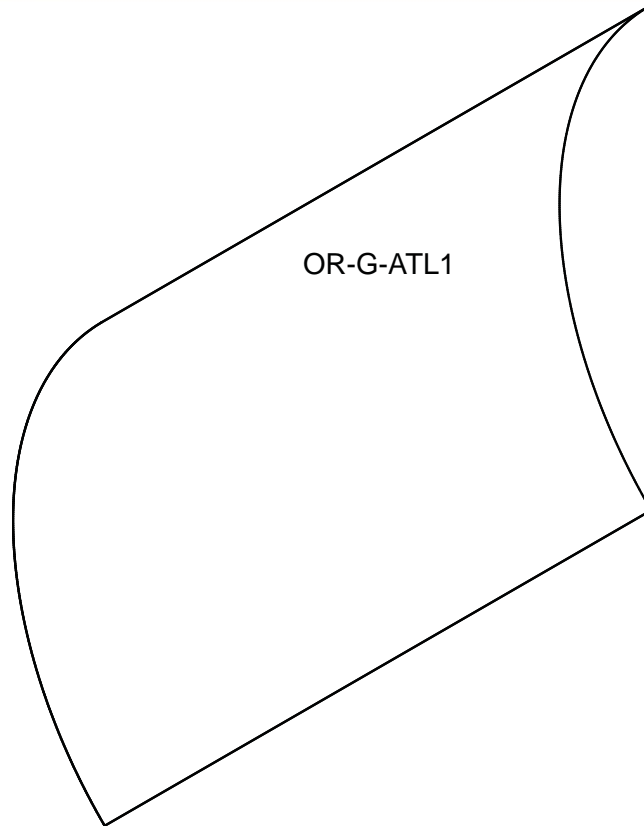

OR-G-ATL1

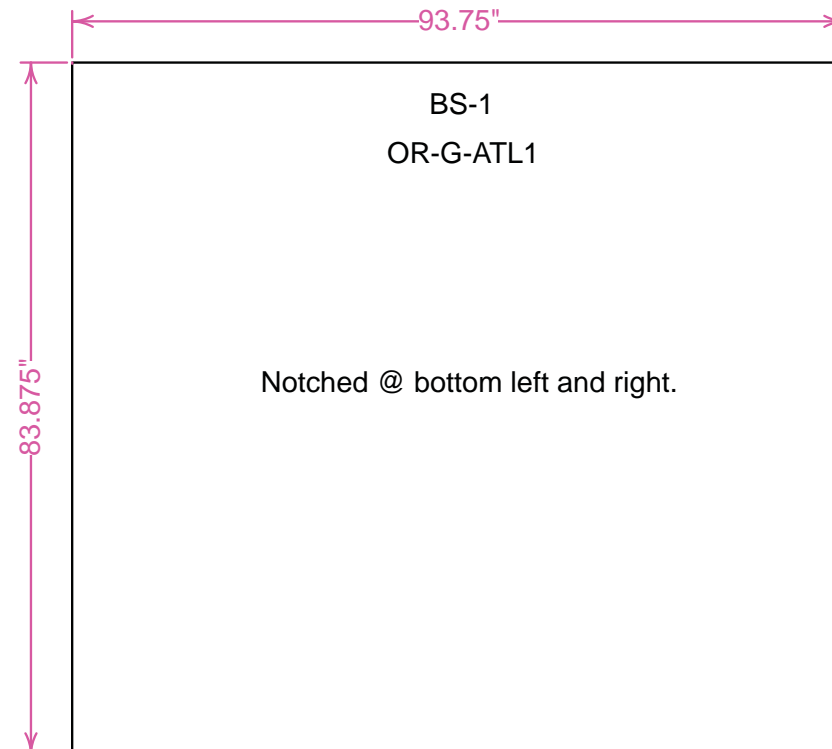

Available Graphics: Dye-Sublimation Graphics Only

Acceptable File Formats:

Illustrator CS3 or below
Photoshop CS3 or below

Art time will be charged if files need to be fixed or altered to meet guidelines. When sending files please be sure to include all support art (fonts, linked images, etc.)

Font Specifications:

Fonts must be converted to outlines.

Bleeds:

All orbital truss graphics require specific bleeds. The sizes listed above represent the finished graphic size. Please keep all logos, type, and critical information at least 1" in from each edge of the finished graphic.

Dye Sublimation: 2" bleed around the perimeter.

Inkjet & UV: 1/2" bleed around the perimeter.

Color:

All files are printed as CMYK format. All critical Pantone colors need to be called out in the file or specified on the order as Coated or Uncoated swatches.

Resolution:

All raster files (either print files or linked files) must be at 100-120 pixels per inch at 100%.

Finishing Details:

When graphics are notched, a 7/8" square is cut in the appropriate location

FS: Graphics mounted to front of the truss system

BS: Graphics mounted to back of the truss system

Dye Sublimation graphics are attached to truss with velcro. Inkjet & UV panels are attached to truss with magnet.

IMPORTANT INFORMATION REGARDING GRAPHIC FILES: Each graphic has a specific code or number located on the graphic.

The electronic print ready files provided must be named accordingly. Using this coding system will allow us to preflight and prepare your files for print more efficiently.

If you fail to provide your graphic files in this format, additional charges may be necessary to complete your printed materials.

3D Rendering:

OR-K-ATL3, 10' x 10' Kit Size



3D Rendering:

OR-K-ATL3, 10' x 10' Kit Size



Dimensions:

OR-K-ATL3, 10' x 10' Kit Size

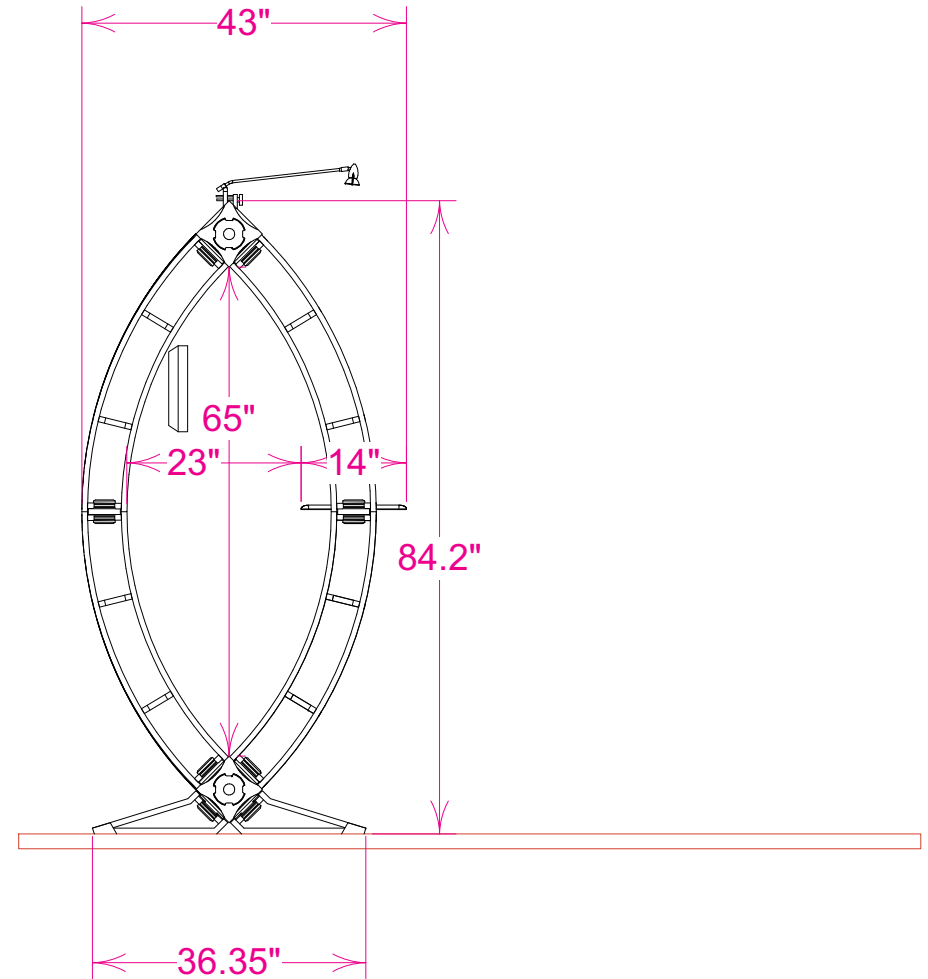
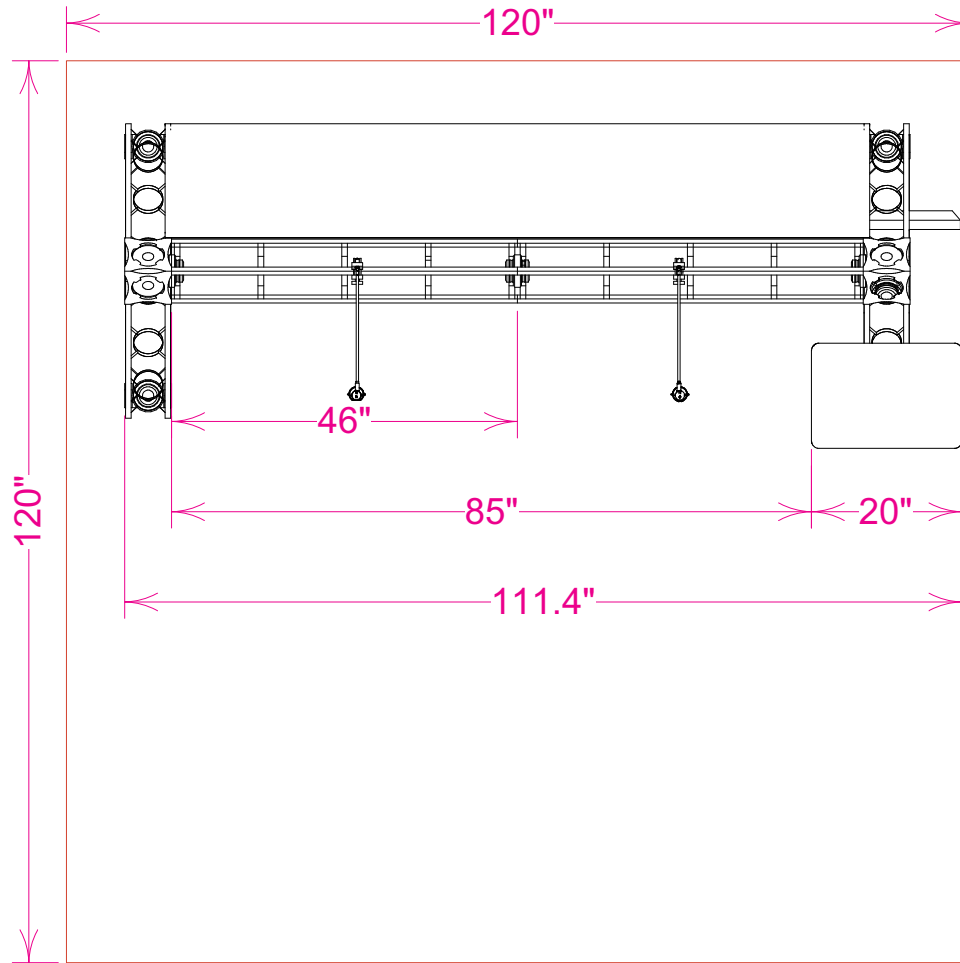

Color Coded Parts:

OR-K-ATL3, 10' x 10' Kit Size

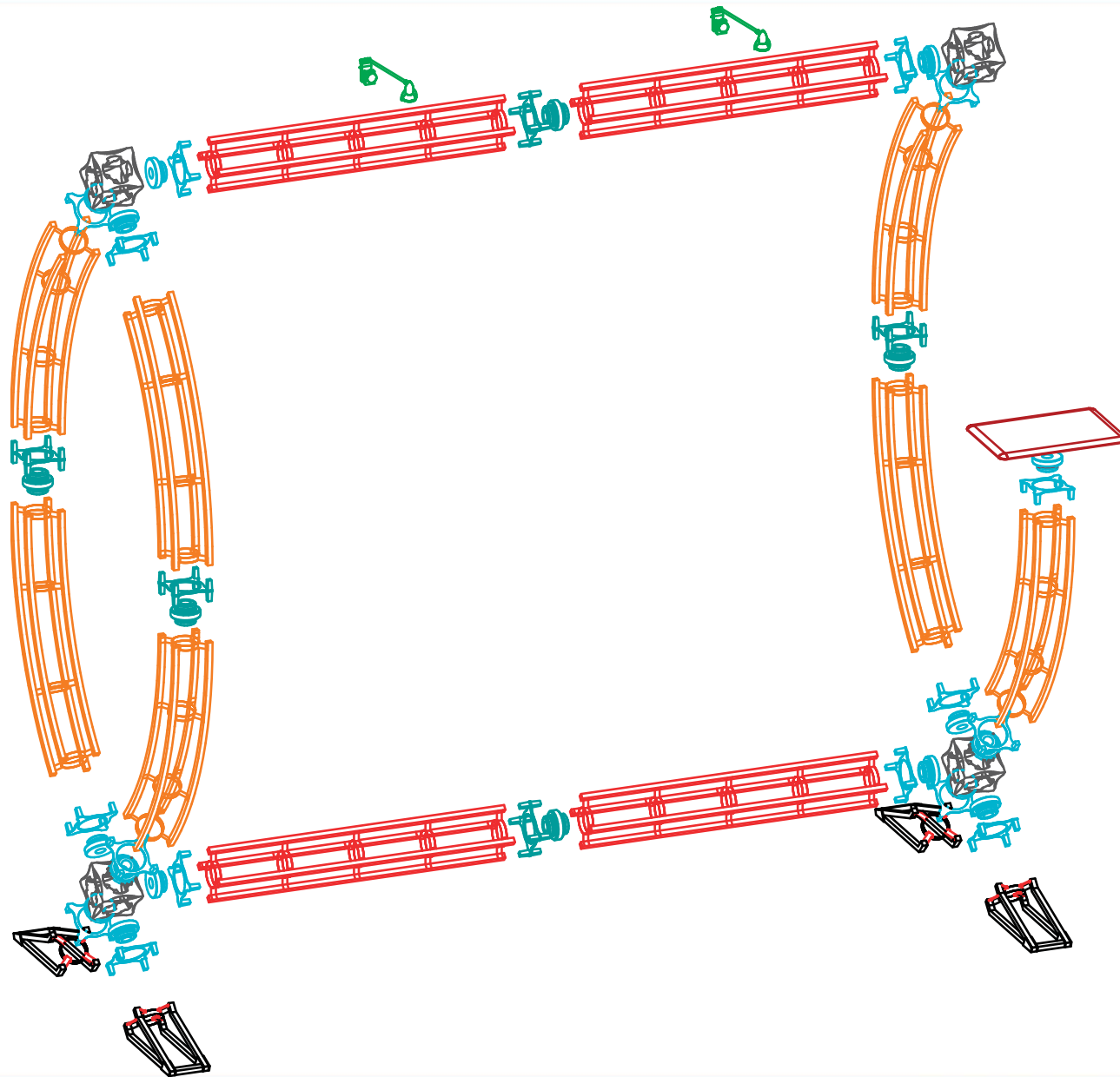

Color Coded Parts:

OR-K-ATL3, 10' x 10' Kit Size

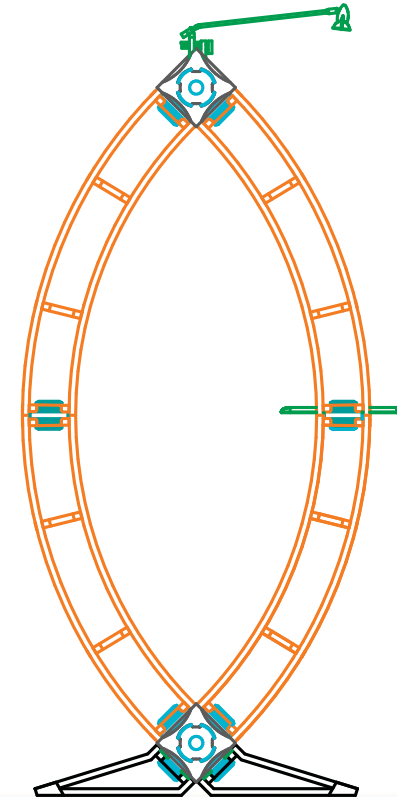
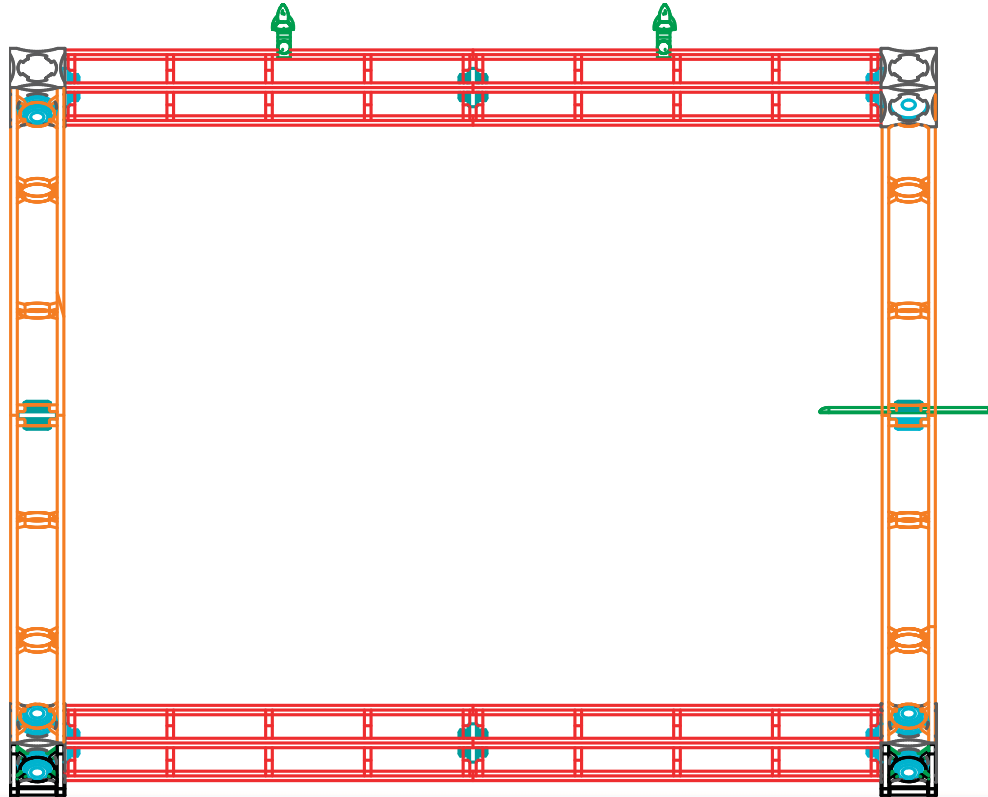
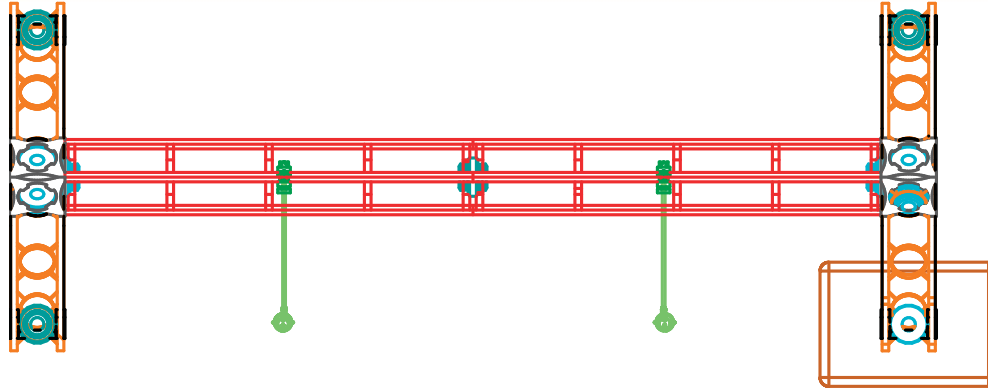

Case Count:

OR-K-ATL3, 10' x 10' Kit Size

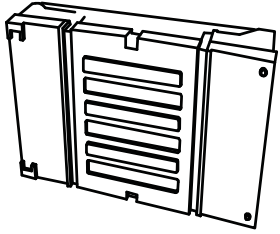

ORBITAL FREIGHT CASE
48" x 36" x 10.5"
(OCFM)

0

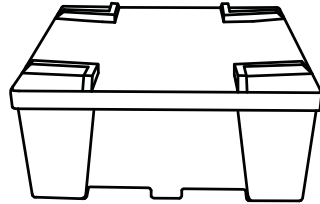

ORBITAL FREIGHT CASE
48" x 36" x 18"
(OCF)

1

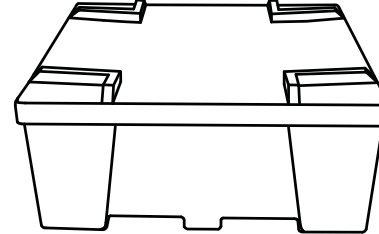

ORBITAL FREIGHT CASE
48" x 48" x 18"
(OCF2)

0

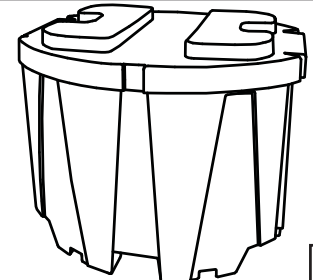

ORBITAL FREIGHT CASE
48" x 44" x 34"
(OCT)

0

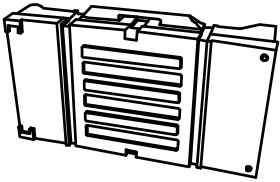

ORBITAL FREIGHT CASE
36" x 24" x 10"
(OCHM)

0

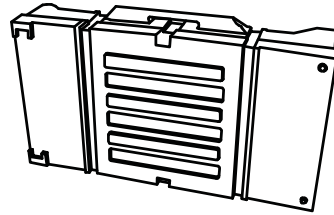

ORBITAL FREIGHT CASE
48" x 24" x 10"
(OCH)

0

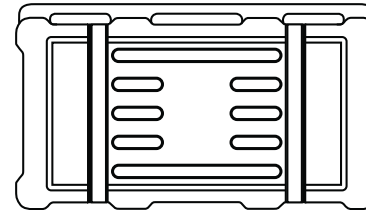

FREIGHT CASE
48" x 24" x 12"
(OCH-2)

0

